

53 10 16

Elektrokolano 90°
z zaciskami montażowymi



PE 100 SDR11 (ISO S5)

10 bar gaz / 16 bar woda

- 4 mm końcówki, wskaźniki poprawności zgrzewu

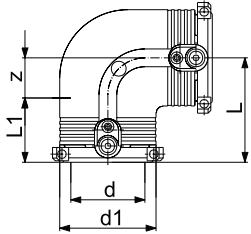

d	Kod	SID	GP	kg	d1	L	L1	z
20	753 101 606	1	10	0,093	35	54	34	20
25	753 101 607	1	10	0,078	35	54	34	20
32	753 101 608	1	10	0,098	44	53	36	17
40	753 101 609	1	10	0,142	54	62	39	23
50	753 101 610	1	10	0,215	66	71	43	28
63	753 101 611	1	10	0,280	81	81	48	32

53 10 18

Elektrokolano 90°
bez zacisków montażowych



PE 100 SDR11 (ISO S5)

10 bar gaz / 16 bar woda

- 4 mm końcówki, wskaźniki poprawności zgrzewu

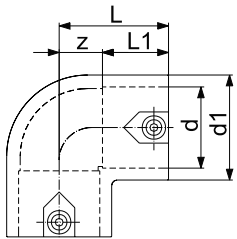

d	Kod	SID	GP	kg	d1	L	L1	z
75	753 101 812	1	-	0,530	97	101	61	40
90	753 101 813	1	14	0,688	113	110	62	48
110	753 101 814	1	8	1,282	136	132	71	61
125	753 101 815	1	10	1,560	151	142	74	68
160	753 101 817	1	4	2,200	196	178	92	86
180	753 101 818	1	1	4,286	219	195	95	100

53 10 18

Elektrokolano 90°
bez zacisków montażowych



PE 100 SDR11 (ISO S5)

10 bar gaz / 16 bar woda

- 4 mm końcówki, wskaźniki poprawności zgrzewu
- dwie oddzielne strefy zgrzewu

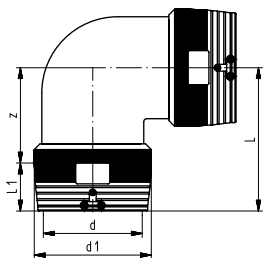

d	Kod	SID	GP	kg	d1	L	L1	z
200	753 101 819	1	-	-	245	265	104	161
225	753 101 820	1	-	-	274	305	112	193
250	753 101 821	1	-	-	305	300	123	177

53 15 16



Elektrokolano 45°
z zaciskami montażowymi

PE 100 SDR11 (ISO S5)

10 bar gaz / 16 bar woda

- 4 mm końcówki, wskaźniki poprawności zgrzewu

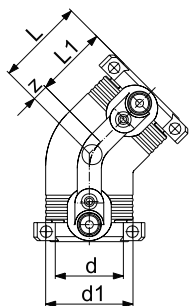

d	Kod	SID	GP	kg	d1	L	L1	z
32	753 151 608	1	20	0,087	44	44	36	8
40	753 151 609	1	10	0,121	54	50	39	11
50	753 151 610	1	10	0,140	66	56	43	13
63	753 151 611	1	10	0,274	81	63	48	15

53 15 18



Elektrokolano 45°

PE 100 SDR11 (ISO S5)

10 bar gaz / 16 bar woda

- 4 mm końcówki, wskaźniki poprawności zgrzewu

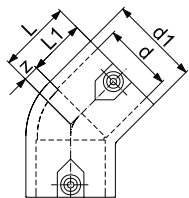

d	Kod	SID	GP	kg	d1	L	L1	z
75	753 151 812	1	-	0,437	97	79	62	17
90	753 151 813	1	16	0,610	112	85	62	23
110	753 151 814	1	6	1,060	136	103	71	32
125	753 151 815	1	6	1,166	151	107	74	33
160	753 151 817	1	5	1,800	196	134	92	42
180	753 151 818	1	1	3,200	217	142	95	47

53 15 18



Elektrokolano 45°

PE 100 SDR11 (ISO S5)

10 bar gaz / 16 bar woda

- 4 mm końcówki, wskaźniki poprawności zgrzewu
- dwie oddzielne strefy zgrzewu

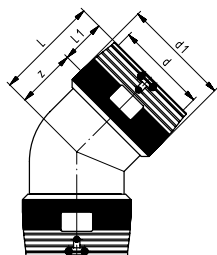

d	Kod	SID	GP	kg	d1	L	L1	z
200	753 151 819	1	-	-	245	215	104	111
225	753 151 820	1	-	-	274	235	112	123
250	753 151 821	1	-	-	305	235	123	112

53 21 16

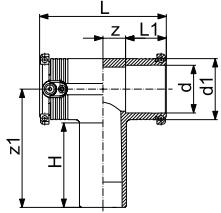

Elektrotrójnik 90°, równoprzelotowy
z zaciskami montażowymi

PE 100 SDR11 (ISO S5)

10 bar gaz / 16 bar woda

- 4 mm końcówki, wskaźniki poprawności zgrzewu

d	Kod	SID	GP	kg	d1	L	L1	z	z1	H
20	753 211 606	1	10	0,100	35	90	34	11	92	67
25	753 211 607	1	10	0,088	35	90	34	11	92	70
32	753 211 608	1	10	0,213	44	102	36	15	100	74
40	753 211 609	1	10	0,176	54	120	39	21	114	82
50	753 211 610	1	5	0,268	66	135	43	24	126	90
63	753 211 611	1	5	0,429	81	152	48	28	150	102

53 20 18

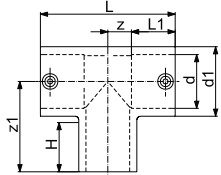

Elektrotrójnik 90°, równoprzelotowy

PE 100 SDR11 (ISO S5)

10 bar gaz / 16 bar woda

- 4 mm końcówki, wskaźniki poprawności zgrzewu

d	Kod	SID	GP	kg	d1	L	L1	z	z1	H
75	753 201 812	1	-	0,597	97	187	61	33	126	78
90	753 201 813	1	8	0,910	112	202	61	41	146	84
110	753 201 814	1	6	1,420	136	242	65	56	161	88
125	753 201 815	1	4	1,980	151	256	75	53	174	92
160	753 201 817	1	3	4,893	196	325	92	71	206	103
180	753 201 818	1	2	6,770	225	344	90	82	250	110

53 20 18

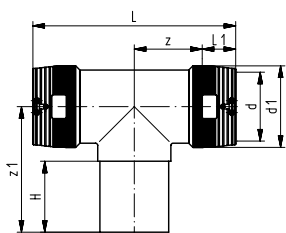

Elektrotrójnik 90°, równoprzelotowy

PE 100 SDR11 (ISO S5)

10 bar gaz / 16 bar woda

- 4 mm końcówki, wskaźniki poprawności zgrzewu
- dwie oddzielne strefy zgrzewu

d	Kod	SID	GP	kg	d1	L	L1	z	z1	H
200	753 201 819	1	-	-	245	560	104	176	250	117
225	753 201 820	1	-	-	274	610	112	193	270	122
250	753 201 821	1	-	-	305	672	123	213	310	148

Elektrotrójnik 90°, redukcyjny (zestaw)



PE100 SDR11 (ISO S5)

10 bar gaz / 16 bar woda

- zaciski montażowe (do średnicy d63)
- 4 mm końcówki, wskaźniki poprawności zgrzewu
- produkt dostarczany jako zestaw z mufą elektrooporową ELGEF Plus oraz redukcją doczołową

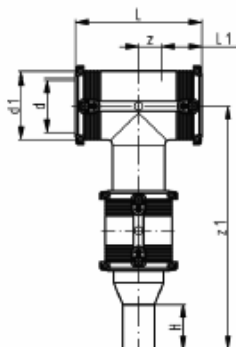

d-d2	Kod	SID	GP	kg	d1	L	L1	z	z1	H
40-20	193 281 004	2	-	0,314	54	120	39	21	244	212
40-25	193 281 005	2	-	0,319	54	120	39	21	244	212
75-40	193 280 998	2	-	1,064	97	187	61	33	296	248
90-50	193 280 999	2	-	1,622	112	202	61	41	336	274
110-63	193 280 961	1	-	2,597	136	242	65	56	336	293
125-63	193 280 963	2	-	3,297	151	256	75	53	361	279
125-110	193 280 965	2	-	3,528	151	256	75	53	389	307
160-125	193 280 969	2	-	8,044	196	325	92	71	451	348
180-90	193 281 032	2	-	11,130	225	344	90	82	487	347
180-110	193 281 033	2	-	11,320	225	344	90	82	495	355

ELGEF® Plus

53 21 10

Elektrotrójnik 90°, redukcyjny

- PE 100 SDR 11 (ISO S5)
- 10 bar Gaz / 16 bar Woda
- 4 mm końcówki
- wskaźnik poprawności zgrzewu
- dwie oddzielne strefy zgrzewu
- *dwie połączone strefy zgrzewu

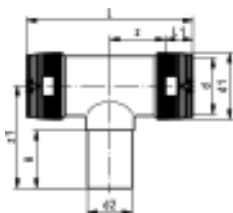

d	d2	Kod	SP	GP	kg	d1	L	L1	z	z1	H
[mm]	[mm]					[mm]	[mm]	[mm]	[mm]	[mm]	[mm]
*110	90	753 211 034				140	255	72	56	245	80
*125	90	753 211 035				156	255	75	53	245	80
160	63	753 211 037	1	2	5.480	196	405	90	113	176	65
160	90	753 211 039	1	2	5.580	196	405	90	113	188	79
160	110	753 211 040	1	2	5.700	196	405	90	113	195	85
*180	90	753 211 041				225	344	90	82	304	79
*180	110	753 211 042				225	344	90	82	307	82
200	90	753 211 059	-	-	11.260	245	557	104	175	215	81
200	110	753 211 060	-	-	11.260	245	557	104	175	218	84
200	160	753 211 063	-	-	11.260	245	557	104	175	236	101
225	90	753 211 069	1	1	13.520	274	615	112	196	226	80
225	110	753 211 070	1	1	13.570	274	615	112	196	235	85
225	160	753 211 073	1	1	14.020	274	615	112	196	255	105
250	110	753 211 080	-	-	11.260	305	668	123	211	245	85
250	160	753 211 083	-	-	11.260	305	668	123	211	264	101

53 20 16



Elektrotrójnik 90° równoprzelotowy lub redukcyjny (zestaw)

- PE 100 SDR 11 (ISO S5)
- 10 bar Gaz / 16 bar Woda
- zaciski montażowe (do średnicy d63)
- 4 mm końcówki
- Wskaźniki poprawności zgrzewu
- Dostarczane jako zestaw z mufą lub redukcją elektrooporową

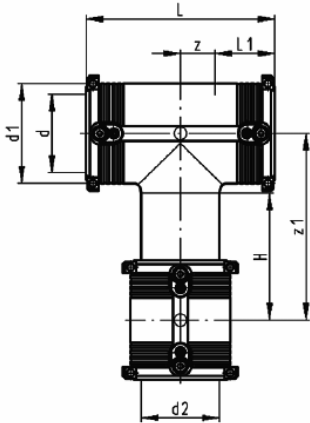

d [mm]	d2 [mm]	Code	SP	kg	d1 [mm]	L [mm]	L1 [mm]	z [mm]	z1 [mm]	H [mm]
20	20	753 201 606	1	0.170	35	90	34	11	92	67
25	25	753 201 607	1	0.170	35	90	34	11	92	70
32	32	753 201 608	1	0.213	44	102	36	15	100	74
40	32	193 281 006	0	0.248	54	120	39	21	127	95
40	40	753 201 609	1	0.295	54	120	39	21	114	82
50	32	193 281 007	1	0.364	66	135	43	24	144	108
50	40	193 281 008	1	0.404	66	135	43	24	140	104
50	50	753 201 610	1	0.419	66	135	43	24	126	90
63	32	193 280 997	1	0.550	81	152	48	28	173	125
63	40	193 281 009	1	0.605	81	152	48	28	169	121
63	50	193 281 010	1	0.618	81	152	48	28	165	117
63	63	753 201 611	1	0.641	81	152	48	28	150	102
90	63	193 281 011	1	1.300	112	202	61	41	182	120
90	90	753 201 613	1	1.450	112	202	61	41	146	84
110	90	193 281 012	1	2.294	136	242	65	56	200	127
110	110	753 201 614	1	2.400	136	242	65	56	161	88
125	90	193 281 013	0	2.850	151	256	75	53	214	132
125	125	753 201 615	1	2.930	151	256	75	53	174	92
160	110	193 281 030	0	6.093	196	325	92	71	271	168
160	160	753 201 617	1	6.664	196	325	92	71	206	103
180	125	193 281 031	0	8.770	225	344	90	82	330	190
180	180	753 201 618	1	9.600	225	344	90	82	250	110

53 90 16

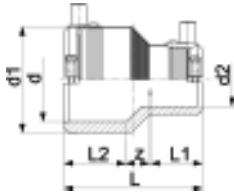

Elektroredukcja
z zaciskami montażowymi

- PE 100 SDR 11 (ISO S5)
- 10 bar gaz / 16 bar woda
- 4 mm końcówki
- wskaźniki poprawności zgrzewu

d [mm]	d2 [mm]	Kod	SP	GP	kg	d1 [mm]	L [mm]	L1 [mm]	L2 [mm]	z [mm]
25	20	753 901 639	-	20	0.059	35	74	34	34	6
32	20	753 901 640	1	20	0.071	44	79	33	36	10
32	25	753 901 641	1	20	0.060	44	79	33	36	10
40	20	753 901 644				54	88	33	40	15
40	25	753 901 645				54	88	33	40	15
40	32	753 901 646	1	20	0.072	54	88	33	39	13
50	32	753 901 651	1	10	0.096	66	96	35	43	18
50	40	753 901 652	1	15	0.136	66	96	39	43	14
63	32	753 901 656	1	10	0.171	81	106	35	48	23
63	40	753 901 657	1	10	0.176	81	106	39	48	19
63	50	753 901 658	1	10	0.189	81	106	43	48	15

53 90 18

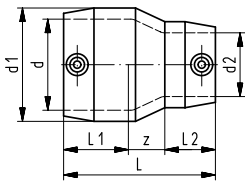

Elektroredukcja

PE 100 SDR11 (ISO S5)

10 bar gaz / 16 bar woda

- 4 mm końcówki, wskaźniki poprawności zgrzewu

d-d2	Kod	SID	GP	kg	d1	L	L1	L2	z
90- 63	753 901 831	1	12	0,390	112	150	64	50	36
110- 90	753 901 833	1	8	0,874	136	171	71	61	39
125- 90	753 901 836	1	6	0,870	152	180	79	61	40
160-110	753 901 834	1	5	1,200	196	226	91	70	65
180-125	753 901 835	1	4	2,000	220	247	97	70	80

53 90 18

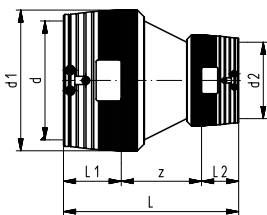

Elektroredukcja

PE 100 SDR11 (ISO S5)

10 bar gaz / 16 bar woda

- 4 mm końcówki, wskaźniki poprawności zgrzewu
- dwie oddzielne strefy zgrzewu

d-d2	Kod	SID	GP	kg	d1	L	L1	L2	z
200-160	753 901 837	1	-	-	245	322	104	90	128
225-160	753 901 838	1	-	-	274	352	112	90	150
250-160	753 901 840	1	-	-	305	348	123	90	135
250-200	753 901 841	1	-	-	305	354	123	104	127

ELGEF® Plus

93 28 09

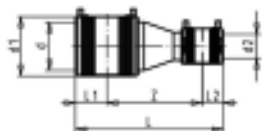

Elektroredukcja (zestaw)

- PE 100 SDR 11 (ISO S5)
- 10 bar Gaz / 16 bar Woda
- 4 mm końcówki
- wskaźniki poprawności zgrzewu
- zaciski montażowe (do średnicy d63)
- dostarczane jako zestaw mufy elektrooporowej ELGEF® Plus oraz redukcji

d [mm]	d2 [mm]	Code	kg	d1 [mm]	L [mm]	L1 [mm]	L2 [mm]	z [mm]
75	40	193 280 992	0.567	96	265	55	40	170
75	50	193 280 993		96	269	55	44	170
75	63	193 280 994		96	273	55	48	170
90	50	193 280 958		113	297	63	44	190
90	75	193 280 995		113	308	63	55	190
110	63	193 280 950		138	326	73	48	205
110	75	193 280 996		138	333	73	55	205
125	63	193 280 953		154	314	79	48	187
125	110	193 280 951		154	367	79	73	215
160	90	193 280 954		196	370	90	63	217
160	125	193 280 952		196	414	90	79	245
180	110	193 280 959		214	413	95	73	245

53 96 16

Elektrokołpak z zaciskami montażowymi

PE 100 SDR11 (ISO S5)

10 bar gaz / 16 bar woda

- wskaźniki poprawności zgrzewu
- 4 mm końcówki

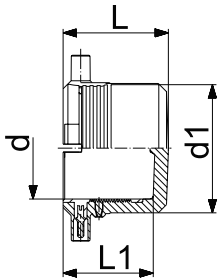

d	Kod	SID	GP	kg	d1	L	L1
20	753 961 606	1	50	0,038	35	52	44
25	753 961 607	1	50	0,030	35	52	44
32	753 961 608	1	50	0,080	44	52	44
40	753 961 609	1	50	0,074	54	56	47
50	753 961 610	1	10	0,086	66	60	49
63	753 961 611	1	10	0,154	81	66	54

53 96 16

Elektrokołpak

PE 100 SDR11 (ISO S5)

10 bar gaz / 16 bar woda

- 4 mm końcówki, wskaźniki poprawności zgrzewu

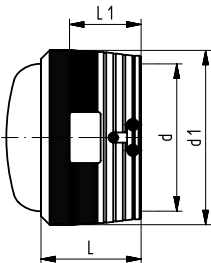

d	Kod	SID	GP	kg	d1	L
160	753 961 617	1	-	-	196	129
200	753 961 619	1	-	-	245	147
225	753 961 620	1	-	-	274	157
250	753 961 621	1	-	-	305	173

53 96 17

Elektrokołpak (zestaw)

PE 100 SDR11 (ISO S5)

10 bar gaz / 16 bar woda

- dostarczany jako zestaw z mufą Elgef Plus
- 4 mm końcówki, wskaźniki poprawności zgrzewu
- *Artykuł zastąpiony kołpakiem (53 96 16)

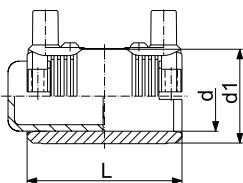

d	Kod	SID	GP	kg	d1	L
75	753 961 712	1	6	0,446	96	110
90	753 961 713	1	3	0,680	113	125
110	753 961 714	1	3	1,126	133	145
125	753 961 715	1	3	1,594	155	158
140	753 961 716	1	3	2,250	175	170
160*	753 961 717	1	1	2,712	197	180
180	753 961 718	1	1	4,136	220	194
200*	753 961 719	1	1	4,906	245	208
225*	753 961 720	1	1	6,500	296	224

20 92 07

Elektromufa, przejście PE / mosiądz z gwintem zewnętrznym z zaciskami montażowymi

PE 100 SDR11 (ISO S5)

10 bar gaz / 16 bar woda

- 4 mm końcówki, wskaźniki poprawności zgrzewu
- produkt dostarczany jako zestaw

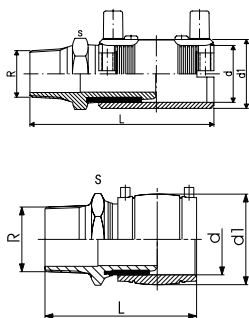

d-R	Kod	SID	GP	kg	d1	L	s
20-1/2"	720 920 756	1	6	0,217	31	110	30
20-1"	720 920 754	2	6	0,344	44	124	40
25-3/4"	720 920 757	1	6	0,280	36	111	35
25-1"	720 920 763	1	6	0,364	44	124	40
32-1/2"	720 920 764	1	6	0,235	44	121	30
32-3/4"	720 920 765	1	6	0,287	44	122	35
32-1"	720 920 758	1	6	0,355	44	117	40
32-1 1/4"	720 920 766	1	6	0,543	54	135	50
32-1 1/2"	720 920 767	1	6	0,685	60	143	60
32-2"	720 920 768	2	6	1,000	81	157	70
40-1"	720 920 771	1	6	0,387	54	133	40
40-1 1/4"	720 920 759	1	6	0,541	54	127	50
40-1 1/2"	720 920 772	1	3	0,694	66	143	60
40-2"	720 920 773	1	3	0,992	81	157	70
50-1"	720 920 776	1	6	0,416	66	141	40
50-1 1/4"	720 920 777	1	3	0,578	66	143	50
50-1 1/2"	720 920 760	1	6	0,670	66	135	60
50-2"	720 920 778	1	3	0,994	81	157	70
63-1"	720 920 781	1	3	0,460	81	151	40
63-1 1/4"	720 920 782	1	3	0,626	81	153	40
63-1 1/2"	720 920 783	1	3	0,741	81	153	60
63-2"	720 920 761	1	3	1,005	81	147	70

20 92 02

Elektromufa, przejście PE / mosiądz z gwintem wewnętrznym z zaciskami montażowymi

PE 100 SDR11 (ISO S5)

10 bar gaz / 16 bar woda

- 4 mm końcówki, wskaźniki poprawności zgrzewu
- produkt dostarczany jako zestaw

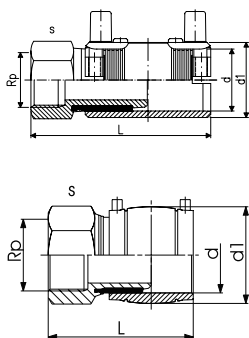

d-Rp	Kod	SID	GP	kg	d1	L	s
32-1"	720 920 258	1	6	0,338	44	108	40
40-1 1/4"	720 920 259	1	6	0,511	54	118	50
50-1 1/2"	720 920 260	1	6	0,744	66	126	60
63-1"	720 920 281	1	3	1,280	81	138	70
63-1 1/4"	720 920 282	2	3	1,230	81	138	70
63-1 1/2"	720 920 283	1	3	1,115	81	138	70
63-2"	720 920 261	1	3	1,016	81	138	70

20 10 07

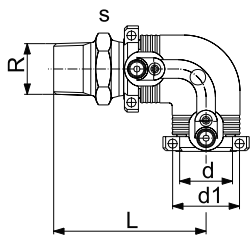

Elektrokolano 90°, przejście PE / mosiądz z gwintem zewnętrznym z zaciskami montażowymi

PE 100 SDR11 (ISO S5)

10 bar gaz / 16 bar woda

- 4 mm końcówki, wskaźniki poprawności zgrzewu
- produkt dostarczany jako zestaw

d-R	Kod	SID	GP	kg	d1	L	s
20-1/2"	720 100 756	2	6	0,240	31	96	30
25-3/4"	720 100 757	2	6	0,260	36	97	35
32-1"	720 100 758	1	6	0,383	44	98	40
32-1 1/4"	720 100 766	2	6	0,500	44	100	50
32-1 1/2"	720 100 767	2	6	0,562	44	100	60
40-1"	720 100 771	1	6	0,528	54	107	50
40-1 1/4"	720 100 759	1	6	0,584	54	109	50
40-1 1/2"	720 100 772	2	6	0,642	54	109	60
50-1"	720 100 776	1	6	0,710	66	116	60
50-1 1/4"	720 100 777	1	6	0,771	66	118	60
50-1 1/2"	720 100 760	1	6	0,757	66	118	60
63-1 1/4"	720 100 782	2	3	1,040	81	128	70
63-1 1/2"	720 100 783	1	3	1,045	81	128	70
63-2"	720 100 761	1	3	1,115	81	132	70

20 10 02

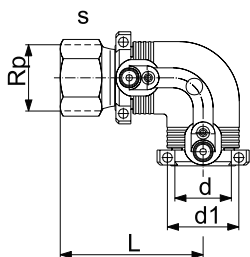

Elektrokolano 90°, przejście PE / mosiądz z gwintem wewnętrznym z zaciskami montażowymi

PE 100 SDR11 (ISO S5)

10 bar gaz / 16 bar woda

- 4 mm końcówki, wskaźniki poprawności zgrzewu
- produkt dostarczany jako zestaw

d-Rp	Kod	SID	GP	kg	d1	L	s
32-1"	720 100 258	1	6	0,365	44	89	40
40-1 1/4"	720 100 259	1	6	0,556	54	100	50
50-1 1/2"	720 100 260	1	6	0,819	66	109	60
63-1"	720 100 281	2	3	1,420	81	123	70
63-1 1/4"	720 100 282	2	3	1,380	81	123	70
63-1 1/2"	720 100 283	2	3	1,305	81	123	70
63-2"	720 100 261	1	3	1,165	81	123	70

20 15 07

Elektrokolano 45°, przejście PE / mosiądz z gwintem zewnętrznym z zaciskami montażowymi



PE 100 SDR11 (ISO S5)

10 bar gaz / 16 bar woda

- 4 mm końcówki, wskaźniki poprawności zgrzewu
- produkt dostarczany jako zestaw

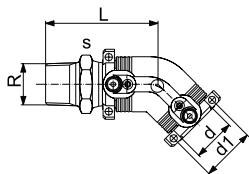

d-R	Kod	SID	GP	kg	d1	L	s
32-1"	720 150 758	2	6	0,374	44	89	40
32-1 1/2"	720 150 767	2	6	0,560	44	91	60
40-1"	720 150 771	2	6	0,510	54	95	50
40-1 1/4"	720 150 759	2	6	0,560	54	97	50
40-1 1/2"	720 150 772	2	6	0,630	54	97	60
50-1"	720 150 776	2	6	0,670	66	101	60
50-1 1/4"	720 150 777	2	6	0,740	66	103	60
50-1 1/2"	720 150 760	2	6	0,720	66	103	60
63-1 1/4"	720 150 782	2	3	0,990	81	110	70
63-1 1/2"	720 150 783	2	3	0,990	81	110	70
63-2"	720 150 761	2	3	1,069	81	114	70

20 15 02

Elektrokolano 45°, przejście PE / mosiądz z gwintem wewnętrznym z zaciskami montażowymi



PE 100 SDR11 (ISO S5)

10 bar gaz / 16 bar woda

- 4 mm końcówki, wskaźniki poprawności zgrzewu
- produkt dostarczany jako zestaw

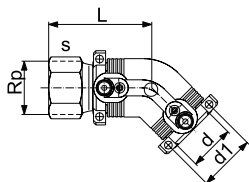

d-Rp	Kod	SID	GP	kg	d1	L	s
32-1"	720 150 258	2	6	0,354	44	80	40
40-1 1/4"	720 150 259	2	6	0,530	54	88	50
50-1 1/2"	720 150 260	2	6	0,780	66	94	60
63-1"	720 150 281	2	3	1,360	81	105	70
63-1 1/4"	720 150 282	2	3	1,320	81	105	70
63-1 1/2"	720 150 283	2	3	1,090	81	105	70
63-2"	720 150 261	2	3	1,090	81	105	70

20 91 00

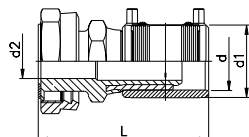

Elektromufa, przejście PE / mosiądz z zaciskami montażowymi,
z luźną nakrętką

PE 100 SDR11 (ISO S5)

16 bar woda, wersja na gaz na specjalne życzenie

- wskaźniki poprawności zgrzewu
- 4 mm końcówki
- w wersji standardowej mufa dostarczana wraz z uszczelką płaską (KTW/WRAS)
- produkt dostarczany jako zestaw

d-Rp	Kod	SID	GP	kg	d1	d2	L
25- ³ / ₄ "	720 910 007	1	8	0,240	36	15	104
25-1"	720 910 017	1	8	0,315	36	16,2	106
32-1"	720 910 008	1	6	0,342	44	20	110
32-1 ¹ / ₄ "	720 910 018	2	6	0,460	44	21,6	114
32-1 ¹ / ₂ "	720 910 028	2	6	0,480	44	21,6	114
40-1"	720 910 009	2	6	0,465	54	20,5	119
40-1 ¹ / ₄ "	720 910 019	2	6	0,520	54	25	123
40-1 ¹ / ₂ "	720 910 029	2	6	0,595	54	27,7	123
50-1"	720 910 020	2	3	0,685	66	20	128
50-1 ¹ / ₄ "	720 910 030	2	3	0,730	66	25	133
50-1 ¹ / ₂ "	720 910 010	2	3	0,774	66	29	133
50-2"	720 910 040	2	3	0,980	66	35,8	137
63-1"	720 910 021	2	3	1,025	81	20	137
63-1 ¹ / ₄ "	720 910 031	2	3	1,060	81	25	141
63-1 ¹ / ₂ "	720 910 041	2	3	1,070	81	29	141
63-2"	720 910 011	1	3	1,235	81	35,8	145

20 10 00

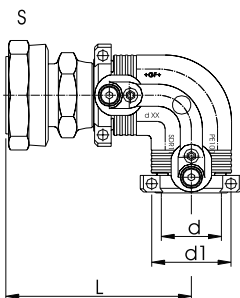

Elektrokolano 90°, przejście PE / mosiądz z zaciskami montażowymi, z luźną nakrętką

PE 100 SDR11 (ISO S5)

16 bar woda, wersja na gaz na specjalne życzenie

- wskaźniki poprawności zgrzewu
- 4 mm końcówki
- w wersji standardowej kolano dostarczane wraz z uszczelką płaską (KTW/WRC)
- produkt dostarczany jako zestaw

d-Rp	Kod	SID	GP	kg	d1	L
25-3/4"	720 100 007	2	8	0,260	36	90
25-1"	720 100 017	2	8	0,335	36	92
32-1"	720 100 008	2	6	0,370	44	91
32-1 1/4"	720 100 018	2	6	0,490	44	95
40-1"	720 100 009	2	6	0,505	54	101
40-1 1/4"	720 100 019	2	6	0,520	54	105
40-1 1/2"	720 100 029	2	6	0,635	54	105
50-1"	720 100 020	2	6	0,760	66	111
50-1 1/2"	720 100 010	2	6	0,850	66	116
50-2"	720 100 040	2	3	1,060	66	120
63-1"	720 100 021	2	3	1,171	81	121
63-1 1/2"	720 100 041	2	3	1,070	81	125
63-2"	720 100 011	2	3	1,375	81	129

20 15 00

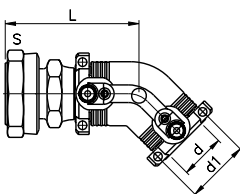

Elektrokolano 45°, przejście PE / mosiądz z zaciskami montażowymi, z luźną nakrętką

PE 100 SDR11 (ISO S5)

16 bar woda, wersja na gaz na specjalne życzenie

- wskaźniki poprawności zgrzewu
- 4 mm końcówki
- w wersji standardowej kolano dostarczane wraz z uszczelką płaską (KTW/WRC)
- produkt dostarczany jako zestaw

d-Rp	Kod	SID	GP	kg	d1	L
32-1"	720 150 008	2	6	0,355	44	82
32-1 1/4"	720 150 018	2	6	0,475	44	86
40-1"	720 150 009	2	6	0,485	54	89
40-1 1/2"	720 150 029	2	6	0,615	54	93
50-2"	720 150 040	2	3	1,024	66	105
63-2"	720 150 011	2	3	1,315	81	112

24 92 07

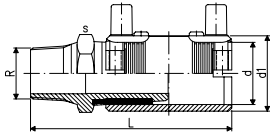

Elektromufa, przejście PE / stal nierdzewna (1.4305)
z gwintem zewnętrznym, z zaciskami montażowymi

PE 100 SDR11 (ISO S5)

10 bar gaz / 16 bar woda

- 4 mm końcówki, wskaźniki poprawności zgrzewu
- produkt dostarczany jako zestaw

d-R	Kod	SID	GP	kg	d1	L	s
20-1/2"	724 920 756	1	6	0,210	31	110	30
25-3/4"	724 920 757	1	6	0,260	36	111	35
32-1"	724 920 758	1	6	0,347	44	117	40
32-1 1/2"	724 920 767	3	6	0,330	44	125	60
40-1 1/4"	724 920 759	1	6	0,519	54	127	50
40-1 1/2"	724 920 772	1	6	0,690	66	143	60
50-1 1/2"	724 920 760	1	6	0,657	66	135	60
63-1 1/2"	724 920 771	1	3	0,904	81	147	70
63-2"	724 920 761	1	3	0,963	81	147	70

24 92 02

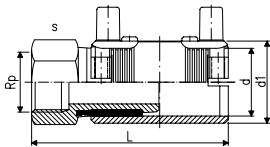

Elektromufa, przejście PE / stal nierdzewna (1.4305)
z gwintem wewnętrznym, z zaciskami montażowymi

PE 100 SDR11 (ISO S5)

10 bar gaz / 16 bar woda

- 4 mm końcówki, wskaźniki poprawności zgrzewu
- produkt dostarczany jako zestaw

d-Rp	Kod	SID	GP	kg	d1	L	s
20-1/2"	724 920 256	2	6	0,197	31	100	30
25-3/4"	724 920 257	1	6	0,253	36	101	35
32-1"	724 920 258	1	6	0,340	44	108	40
40-1 1/4"	724 920 259	1	6	0,505	54	118	50
50-1 1/2"	724 920 260	1	6	0,725	66	126	60
63-2"	724 920 261	1	3	0,995	81	138	70

24 10 07

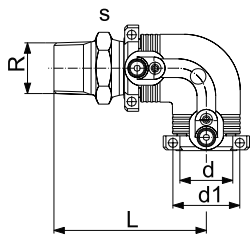

Elektrokolano 90°, przejście PE / stal nierdzewna (1.4305)
z gwintem zewnętrznym, z zaciskami montażowymi

PE 100 SDR11 (ISO S5)

10 bar gaz / 16 bar woda

- 4 mm końcówki, wskaźniki poprawności zgrzewu
- produkt dostarczany jako zestaw

d-R	Kod	SID	GP	kg	d1	L	s
20-1/2"	724 100 756	2	6	0,211	31	96	30
25-3/4"	724 100 757	2	6	0,230	36	97	35
32-1"	724 100 758	2	6	0,370	44	98	40
40-1 1/4"	724 100 759	2	6	0,560	54	109	50
40-1 1/2"	724 100 772	2	6	0,730	54	109	60
50-1 1/2"	724 100 760	2	6	0,730	66	118	60
63-1 1/2"	724 100 771	2	3	1,040	81	132	70
63-2"	724 100 761	2	3	1,105	81	132	70

24 10 02

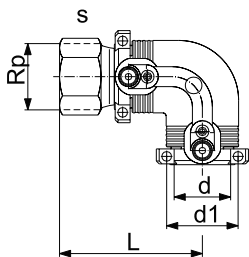

Elektrokolano 90°, przejście PE / stal nierdzewna (1.4305)
z gwintem wewnętrznym, z zaciskami montażowymi

PE 100 SDR11 (ISO S5)

10 bar gaz / 16 bar woda

- 4 mm końcówki, wskaźniki poprawności zgrzewu
- produkt dostarczany jako zestaw

d-Rp	Kod	SID	GP	kg	d1	L	s
20-1/2"	724 100 256	2	6	0,211	31	86	30
25-3/4"	724 100 257	2	6	0,237	36	87	35
32-1"	724 100 258	2	6	0,360	44	89	40
40-1 1/4"	724 100 259	2	6	0,545	54	100	50
50-1 1/2"	724 100 260	2	6	0,805	66	109	60
63-2"	724 100 261	2	3	1,135	81	123	70

24 15 07



Elektrokolano 45°, przejście PE / stal nierdzewna (1.4305)
z gwintem zewnętrznym, z zaciskami montażowymi

PE 100 SDR11 (ISO S5)

10 bar gaz / 16 bar woda

- 4 mm końcówki, wskaźniki poprawności zgrzewu
- produkt dostarczany jako zestaw

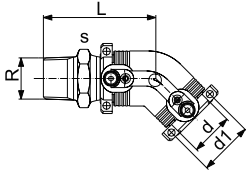

d-R	Kod	SID	GP	kg	d1	L	s
32-1"	724 150 758	2	6	0,360	44	98	40
40-1 1/4"	724 150 759	2	6	0,540	54	97	50
50-1 1/2"	724 150 760	2	6	0,700	66	103	60
63-2"	724 150 761	2	3	1,045	81	114	70

24 15 02



Elektrokolano 45°, przejście PE / stal nierdzewna (1.4305)
z gwintem wewnętrznym, z zaciskami montażowymi

PE 100 SDR11 (ISO S5)

10 bar gaz / 16 bar woda

- 4 mm końcówki, wskaźniki poprawności
- produkt dostarczany jako zestaw

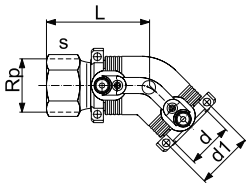

d-Rp	Kod	SID	GP	kg	d1	L	s
32-1"	724 150 258	2	6	0,350	44	80	40
40-1 1/4"	724 150 259	2	6	0,525	54	88	50
50-1 1/2"	724 150 260	2	6	0,765	66	94	60
63-2"	724 150 261	2	3	1,060	81	105	70